



Electrolux



electrolux.com/register



EOF4P0PX2
EOF7P00H
EOF7P86H2
EOM7P00Z
EOM7P10H
KOFCP00H
KOFCP30H
KOFCP86H
KOFFP0PX

OOPP00NB
XOP3PNK

1. SAFETY INFORMATION.....	3
2. SAFETY INSTRUCTIONS.....	4
3. PRODUCT DESCRIPTION.....	7
4. BEFORE FIRST USE.....	7
5. DAILY USE.....	7

6. HINTS AND TIPS.....	10
7. CARE AND CLEANING.....	11
8. TROUBLESHOOTING.....	13
9. ENERGY EFFICIENCY.....	13
10. ENVIRONMENTAL CONCERNS.....	14

1. SAFETY INFORMATION

Before the installation and use of the appliance read the supplied instructions carefully. The manufacturer is not responsible for any injuries or damage that result from incorrect installation or usage. Always keep the instructions in a safe and accessible location for future reference.

1.1 Children and vulnerable people safety

- This appliance can be used by children aged from 8 years and above and persons with reduced physical, sensory or mental capabilities or lack of experience and knowledge if they have been given supervision or instruction concerning the use of the appliance in a safe way and understand the hazards involved. Children of less than 8 years of age and persons with very extensive and complex disabili-

ties shall be kept away from the appliance unless continuously supervised.

- Children should be supervised to ensure that they do not play with the appliance.
- Keep packaging away from children and dispose of it properly.
- **WARNING:** The appliance and its accessible parts become hot during use. Keep children and pets away during use and cooling.
- Activate the child safety device, if available.
- Children must not clean or maintain the appliance without supervision.

1.2 General Safety

- This appliance is for cooking purposes only.
- This appliance is designed for single household domestic use in an indoor environment.
- This appliance may be used in offices, hotel guest

rooms, bed & breakfast guest rooms, farm guest houses, and other similar accommodation where such use does not exceed average domestic usage levels.

- Do not use the appliance before installing it in the built-in structure.
- Disconnect the appliance from the power supply before carrying out any maintenance.
- If the supply cord is damaged, it must be replaced by the manufacturer, its authorised service centre or similarly qualified persons to avoid an electrical hazard.
- **WARNING:** Ensure that the appliance is switched off before replacing the lamp to avoid the possibility of electric shock.
- **WARNING:** The appliance and its accessible parts be-

come hot during use. Care should be taken to avoid touching heating elements or the surface of the appliance cavity.

- Always use oven gloves to remove or insert accessories or ovenware.
- To remove the shelf supports first pull the front of the shelf support and then the rear end away from the side walls. Install the shelf supports in the opposite sequence.
- Do not use a steam cleaner to clean the appliance.
- Do not use harsh abrasive cleaners or sharp metal scrapers to clean the glass door since they can scratch the surface, which may result in shattering of the glass.
- Before pyrolytic cleaning, remove all accessories and excessive deposits/spills from the appliance cavity.

2. SAFETY INSTRUCTIONS

2.1 Installation

WARNING!

Only a qualified person must install this appliance.

- Remove all the packaging.
- Do not install or use a damaged appliance.

- Follow the installation instructions available on our website.
- Be careful when moving the appliance, as it is heavy. Use safety gloves and enclosed footwear.
- Do not pull the appliance by the handle.
- Install the appliance in a safe and suitable location that meets installation requirements.
- Keep the minimum distance from other appliances and units.

- Before mounting the appliance, ensure it is level and that the door opens without any restraint.
- The appliance is equipped with an electric cooling system. It must be operated with the electric power supply.

2.2 Electrical connection

WARNING!

Risk of fire and electric shock.

- All electrical connections should be made by a qualified electrician.
- Make sure the parameters on the rating plate are compatible with the electrical ratings of the mains power supply.
- The appliance must be earthed. Always use a correctly installed shockproof socket.
- Do not use multi-plug adapters and extension cables.
- Avoid damaging the mains plug and cable. If replacement is needed, it must be done by our Authorized Service Centre.
- Do not let mains cables touch or come near the appliance door or the niche below, especially when it operates or the door is hot.
- Shock protection of live and insulated parts must be fastened securely and should not be removable without tools.
- Connect the mains plug to the socket only at the end of installation. Ensure access to the mains plug after installation.
- If the mains socket is loose, do not connect the mains plug.
- Do not disconnect the appliance by pulling on the mains cable. Always pull on the mains plug.
- Use only correct isolation devices: line protecting cut-outs, fuses (screw type fuses removed from the holder), earth leakage trips and contactors.
- The electrical installation must have an isolation device that disconnects the appliance from the mains at all poles, with a contact opening width of at least 3 mm.
- Fully close the appliance door before you connect the mains plug to the mains socket.
- This appliance is supplied with a main plug and a main cable.

Cable types applicable for installation or replacement for Europe:

H07 RN-F, H05 RN-F, H05 RRF, H05 VV-F, H05 V2V2-F (T90), H05 BB-F

For the section of the cable refer to the total power on the rating plate. You can also refer to the table:

Total power (W)	Section of the cable (mm ²)
maximum 1,380	3x0.75
maximum 2,300	3x1
maximum 3,680	3x1.5

The earth cord (green / yellow cable) must be 2 cm longer than the brown phase and blue neutral cables.

2.3 Use

WARNING!

Risk of injury, burns and electric shock or explosion.

- Do not change the specification of the appliance.
- Ensure ventilation openings are not blocked.
- Do not let the appliance stay unattended during operation.
- Deactivate the appliance after each use.
- Be careful when opening the appliance door during operation, as hot air and flammable mixtures from alcohol ingredients can be released.
- Do not operate the appliance with wet hands or when it comes in contact with water.
- Do not apply pressure on the open door.
- Do not use the appliance as a work surface or as a storage surface.
- Keep sparks and open flames away from the appliance when the door is open.
- Use only approved glass and jars for preserving.
- Do not place flammable products near the appliance.

WARNING!

Risk of damage to the appliance.

- To prevent damage or discoloration to the enamel:
 - do not place ovenware or objects directly on the cavity bottom.
 - do not place aluminum foil directly on the cavity bottom.
 - do not put water directly into the hot appliance.
 - do not leave moist dishes and food in the appliance after cooking.

- be careful when removing or installing accessories.
- Enamel or stainless steel discoloration does not affect performance of the appliance.
- Use a deep pan for moist cakes, as fruit juices can cause permanent stains.
- Always cook with the appliance door closed.
- If the appliance is installed behind a furniture panel, do not close the panel during use or until the appliance is fully cooled to prevent heat and moisture damage.
- Concerning the lamp(s) inside this product and spare part lamps sold separately: These lamps are intended to withstand extreme physical conditions in household appliances, such as temperature, vibration, humidity, or are intended to signal information about the operational status of the appliance. They are not intended to be used in other applications and are not suitable for household room illumination.
- This product contains a light source of energy efficiency class G.
- Use only lamps with the same specifications.
- To repair the appliance contact the Authorised Service Centre. Use original spare parts only.

2.4 Care and cleaning

WARNING!

Risk of injury, fire, or damage to the appliance.

- Before maintenance, deactivate the appliance and unplug it from the mains.
- Ensure the appliance is cold to avoid glass breakage. If the door glass panels are damaged, contact the authorized service centre for replacement.
- Be careful when you remove the door from the appliance, it is heavy.
- Clean and dry the appliance, its cavity, and accessories after each use to prevent steam condensation, corrosion, and surface deterioration.
- Use a microfibre cloth, warm water, and neutral detergents for cleaning the appliance and accessories. Do not use abrasive products, pads, solvents, sharp-edged or metal objects.

- Follow safety instructions on packaging when using an oven spray.

Pyrolytic cleaning

- Read all instructions for pyrolytic cleaning
- Before carrying out the pyrolytic cleaning and initial preheating remove from the oven cavity:
 - any excess food residues, oil or grease spills / deposits.
 - any removable objects (including shelves, side rails, etc., provided with the appliance) especially any non-stick pots, pans, trays, utensils, etc.
- Keep children away during pyrolytic cleaning, as the appliance becomes very hot and releases hot air from the front vents.
- Pyrolytic cleaning releases fumes from cooking residues and construction materials. Ensure good ventilation during and after the initial preheating and pyrolytic cleaning.
- Do not spill or apply water on the oven door during and after the pyrolytic cleaning to avoid damaging the glass panels.
- Fumes from pyrolytic ovens / cooking residues are not harmful to humans, including children, or persons with medical conditions.
- Keep pets away from the appliance during and after pyrolytic cleaning and the initial preheating phase. Small pets (especially birds and reptiles) can be highly sensitive to temperature changes and emitted fumes.
- Non-stick surfaces on pots, pans, trays, and utensils can be damaged by high-temperature pyrolytic cleaning and may release low-level harmful fumes.

2.5 Disposal

WARNING!

Risk of injury or suffocation.

- Contact your municipal authority for information on how to dispose of the appliance.
- Disconnect the appliance from the mains, then cut off and dispose of the electrical cable.

3. PRODUCT DESCRIPTION

3.1 General overview

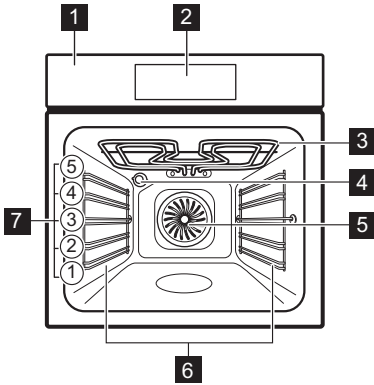

- 1 Control panel
- 2 Display
- 3 Heating element
- 4 Lamp

- 5 Fan
- 6 Shelf support, removable
- 7 Shelf positions

3.2 Touch fields

	To turn the appliance on and off.
	To navigate the menu.
	To adjust settings.
	Press to set the function: AirFry.
	To set assisted cooking function.
	To set timer functions.
	To enter settings.
	To confirm your selection.

4. BEFORE FIRST USE

4.1 Setting the time

1. Press or to adjust the hours and minutes.
2. Press to confirm.

4.2 Initial preheating and cleaning

1. Preheat the empty appliance to remove any odours. Ventilate the room.
2. Remove all accessories and shelf supports.

3. Set each function to maximum temperature and let the appliance operate for specified durations: 1 h, 15 min, 15 min. Refer to Daily use.
4. Turn off the appliance and let it cool down.
5. Clean with a microfiber cloth, warm water, and mild detergent. Replace accessories and shelf supports.

5. DAILY USE







5.1 Heating functions

- True Fan Cooking:** Even baking, tenderness, drying
- Conventional Cooking:** Traditional baking

AirFry: Frying food with less oil and without baking paper.

Frozen Foods: French fries, potato wedges, spring rolls





Pizza Function: Baking pizza

	Bottom Heat: Baking cakes
	Defrost: Defrosting
	Moist Fan Baking: Baking
	Grill: Toasting, grilling
	Turbo Grilling: Roasting meat, browning
	Reheat: Heating up, cooking

To change the function, press  to switch the appliance off, then press it again to turn it back on.

The lamp may turn off automatically at a temperature below 80°C during some oven functions.







5.2 Setting: Heating functions



1. Press  to turn on the appliance.
2. Press  or  to navigate functions.
3. Press  or  to set the temperature.
4. Press **OK**.

 Progress bar - visually indicates when the appliance reaches the set temperature or when the cooking time comes to an end.

>> Fast Heat Up - press and hold **OK** for 3 seconds during heating up phase to shorten the heating time. It is available for some heating functions. Fan may turn on automatically.









5.3 Timer

1. Press .
 2. Press  or  to select a timer function.
 3. Press  or  to set the time. Press **OK**.
- To cancel a timer function, press and hold for 3 seconds .















Timer functions	
	Set a countdown. When the timer ends, the signal sounds.
	Set a countdown. When the timer ends, the signal sounds and the cooking stops.
	To postpone the start and / or end of cooking.











5.4 Setting: Assisted Cooking

Assisted Cooking submenu consists of programmes that are designed for dedicated dishes. Programmes start with a suitable setting. You can adjust the time and the temperature during cooking.







1. Press  to turn on the appliance.
2. Press .
3. Press  or  to select assisted cooking functions.
4. Press  or  to set the temperature. Press **OK**.
5. Press  or  to set the cooking time. Press **OK** to select a function.
6. When the function ends, check if the food is ready. Extend the cooking time, if needed. For assisted cooking with food probe the procedure is the same.

Submenu: Assisted Cooking



Legend	
	Preheat the appliance before you start cooking.
	Shelf level. Refer to Product description.
Dishes	
	Pizza   2 ; baking tray lined with baking paper
	Chicken 1 - 1.5 kg; fresh  2 ; casserole dish on baking tray Turn the chicken after half of the cooking time to get an even browning.
	Beef 1 - 1.5 kg; 4 - 5 cm thick pieces  2 ; baking tray Fry the meat for a few minutes in a hot pan. Insert to the appliance.
	Fillets   3 ; casserole dish on wire shelf
	Lasagne 1 - 1.5 kg  2 ; casserole dish on wire shelf
	Quiche  2 ; baking tin on wire shelf

Dishes	
 Potatoes 1 kg	 2; baking tray Put the whole potatoes with skin on baking tray.
 Vegetable gratin 1 - 1.5 kg	 3; baking tray lined with baking paper Cut the vegetables into pieces.
 Muffins	  3 ; muffin tray on wire shelf
 Ciabatta 0.8 kg	  2 ; baking tray lined with baking paper More time needed for white bread.

5.5 Changing: Settings



1. Press  to turn on the appliance.
2. Press  to access settings.
3. Press  or  to adjust settings. Press **OK**.
4. Press  or  to adjust value.
5. Press **OK** to confirm or exit adjustment mode.
6. Press  to exit settings.

Submenu: Settings

Setting	Value
01 Pyrolytic Cleaning	Cleaning programmes
02 Time of day	Change
03 Light	On / Off
04 Fast Heat Up	On / Off
05 Uptimer	On / Off
06 Display brightness	1 - 5
07 Key tones	Beep, Clic, None
08 Buzzer volume	1 - 4
09 -	-
10 Food Sensor ¹⁾	1  - Alarm, 2  - Alarm and stop

Setting	Value
11 Cleaning Reminder ¹⁾	On / Off
12 -	-
13 Demo mode	Activation code: 2468
14 Software version	Check
15 Reset all settings	Yes / No

¹⁾ selected models only



Settings by default start at **02**. Use the  and  to navigate.

5.6 Lock

This function prevents an accidental change of the appliance function.

When activated while the appliance is in use, it locks the control panel and the door ensuring that the current cooking settings continue uninterrupted.

When activated while the appliance is off, it keeps the control panel locked, preventing the appliance from being turned on unintentionally.

  - press and hold to turn on and off the function.

 - flashes 3 times when the lock is turned on.

5.7 Accessories



Accessories available depending on model. Scan the QR code to check how to use accessories supplied with your appliance. You can order optional accessories separately. For more information, please contact your local supplier.

A small indentation at the top increases safety and provides tilt protection. The rim around the shelf prevents cookware from slipping off the shelf.

Insert the accessory (wire shelf / tray) between the guide bars of the shelf support. Make sure that the shelf touches the back of the oven interior and the feet point down.

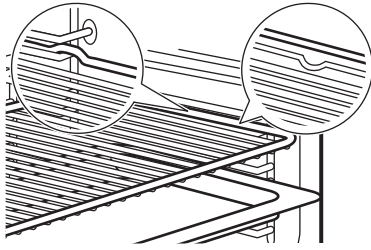

If your tray has a slope, position it towards the back of the oven interior.

If there is an inscription on the accessory, make sure it is facing you.

If you are using a tray with holes, place the tray / pan underneath to collect dripping liquids.







6. HINTS AND TIPS

6.1 Cooking recommendations

The temperature and cooking times in the tables are for guidance only. They depend on the recipes, quality and quantity of the ingredients used. If you cannot find the settings for a specific recipe, look for a similar one.





Count the shelf positions from the bottom of the oven floor.





Symbols used in the tables:

	Food type
	Heating function
	Temperature
	Shelf position
	Cooking time (min)
	Additional information

6.2 Moist Fan Baking

For the best results follow suggestions listed in the table below.

	°C			
Sweet rolls, 16 pieces	180	2	20 - 30	1)
Rolls, 9 pieces	180	2	30 - 40	1)
Pizza, frozen, 0.35 kg	220	2	10 - 15	2)
Swiss Roll	170	2	25 - 35	1)
Brownie	175	3	25 - 30	1)
Soufflé, 6 pieces	200	3	25 - 30	3)
Sponge flan base	180	2	15 - 25	4)

	°C			
Victoria sandwich	170	2	40 - 50	5)
Poached fish, 0.3 kg	180	3	20 - 25	1)
Whole fish, 0.2 kg	180	3	25 - 35	1)
Fish fillet, 0.3 kg	180	3	25 - 30	6)
Poached meat, 0.25 kg	200	3	35 - 45	1)
Shashlik, 0.5 kg	200	3	25 - 30	1)
Cookies, 16 pieces	180	2	20 - 30	1)
Macaroons, 24 pieces	180	2	25 - 35	1)
Muffins, 12 pieces	170	2	30 - 40	1)
Savory pastry, 20 pieces	180	2	25 - 30	1)
Short crust biscuits, 20 pieces	150	2	25 - 35	1)
Tartlets, 8 pieces	170	2	20 - 30	1)
Vegetables, poached, 0.4 kg	180	3	35 - 45	1)
Vegetarian omelette	200	3	25 - 30	6)
Mediterranean vegetables, 0.7 kg	180	4	25 - 30	1)

1) Use baking tray or dripping pan.

2) Use wire shelf.

3) Use ceramic ramekins on wire shelf.











4) Use flan base tin on wire shelf.









5) Use baking dish on wire shelf.

6) Use pizza pan on wire shelf.

6.3 Information for test institutes

Tests according to IEC 60350-1.

		°C		
Small cakes, 20 per tray				
	3	170	20 - 35	1)
	3	150 - 160	20 - 35	1)
	2 and 4	150 - 160	20 - 35	1)
Apple pie, 2 tins Ø20 cm				
	2	180	70 - 90	2)
	2	160	70 - 90	2)
Fatless sponge cake, cake mould Ø26 cm				
	2	170	40 - 50	2) 3)
	2	160	40 - 50	2) 3)

		°C		
	2 and 4	160	40 - 60	2) 3)
Shortbread				
	3	140 - 150	20 - 40	1)
	2 and 4	140 - 150	25 - 45	1)
	3	140 - 150	25 - 45	1)
Toast				
	4	max.	1 - 5	2) 3)

1) Use Baking tray.

2) Use Wire shelf.

3) Preheat the appliance for 10 minutes.

7. CARE AND CLEANING

7.1 Notes on cleaning

- Use a cleaning solution for metal surfaces.
- Moisture can condense in the appliance or on the door glass panels. To decrease the condensation, let the appliance work for 10 minutes before cooking. Do not store food in the appliance for longer than 20 minutes.
- Do not clean the accessories in a dishwasher.

7.2 Removing the shelf supports







1. Make sure the appliance is cold.
2. Pull the front of the shelf support away from the side wall.
3. Pull the rear end of the shelf support away from the side wall and remove it.
4. Put the shelf supports back to the initial position. Repeat the steps in the reverse order.

If the telescopic runners are supplied, its retaining pins must point to the front.

7.3 Pyrolytic Cleaning

This programme burns off residual dirt in the appliance. Use it whenever your appliance needs a deep cleaning.

If there are other appliances installed in the same cabinet, do not use them at the same time as this function. It can cause damage to the oven.

1. Make sure the appliance is cold.
2. Remove all accessories.
3. Clean the oven interior and the inner door glass with warm water, a soft cloth and a mild detergent.
4. Press  to turn on the appliance.
5. Press .
6. Press  or  to select **01**. Press **OK**.
7. Press  or  to select cleaning duration. Press **OK**.

Cleaning	Duration
Light cleaning	1 h
Normal cleaning	1 h 30 min
Thorough cleaning	2 h 30 min

When the cleaning starts, the oven door is locked and the lamp is off. Do not start the function if you did not fully close the oven door. The cooling fan works at a higher speed.

8. When the cleaning ends, turn off the appliance and wait until it is cold. Clean the oven interior with a soft cloth.

7.4 Cleaning Reminder

When ✨ flashes on the display after cooking session, the appliance reminds you to clean it with pyrolytic cleaning. You can turn off the reminder in the submenu: Settings. Refer to Daily use, Changing: Settings

7.5 Removing and installing door

You can remove the oven door and the internal glass panels to clean them. Read the whole "Removing and installing door" instruction before you remove the glass panels.

⚠ CAUTION!

Do not use the appliance without the glass panels.

1. Open the door fully and hold both hinges.

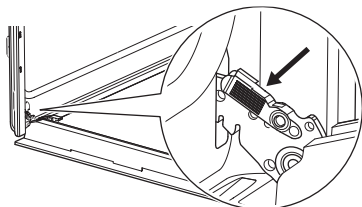

2. Lift and pull the latches until they click.

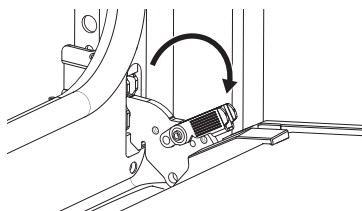

3. Close the oven door halfway to the first opening position. Then lift and pull to remove the door from its seat.

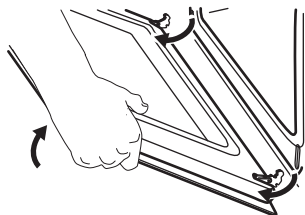

4. Put the door on a soft cloth on a stable surface.
5. Hold the door trim **A** on the top edge of the door at the two sides and push inwards to release the clip seal.

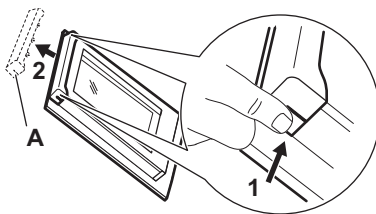

6. Pull the door trim to the front to remove it.
7. Hold the door glass panels on their top edge one by one and pull them up out of the guide. Make sure the glass slides out of the supports completely.

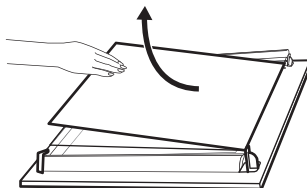

8. Clean the glass panels with water and soap. Dry the glass panels carefully. Do not clean the glass panels in the dishwasher.
9. After cleaning, install the glass panels and the oven door. Make sure that you put the glass panels back in the correct sequence. Check for the symbol / printing on the side of the glass panel. If the door is installed correctly, you will hear a click when closing the latches.

ⓘ The printing zone **B** (if present) must face the oven interior.

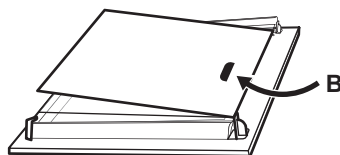

7.6 Replacing the lamp

Disconnect the appliance from the mains and wait until it is cold.

Replace the lamp with a suitable 300 °C heat-resistant lamp.

Back lamp

1. Turn the glass cover to remove it.

2. Clean the glass cover.
3. Replace the lamp.

4. Install the glass cover.

8. TROUBLESHOOTING

If you cannot find a solution to the problem yourself, contact your dealer or an Authorised Service Centre. Service details are on the rating plate, located on the front frame. It is visible when you open the door. Do not remove the rating plate.

If the display shows an error code that is not in this table, turn the house fuse off and on to restart the appliance. If the error code recurs contact an Authorised Service Centre.

You cannot activate or operate the appliance. - The appliance is not connected to an electrical supply or it is connected incorrectly.

The appliance does not heat up.

- The door is not closed correctly.

- Lock is activated.
- Automatic switch-off is activated.

The lamp does not work. - The lamp is burnt out. Replace the lamp.

The lamp is turned off. - Moist Fan Baking - is activated.

The display shows "00:00". - There was a power cut. Set the time of day.

Err C3 - Close the door. Turn the appliance off and on. Check if the door lock is not broken.

Err F102 - Close the door. Check if the door lock is not broken.

9. ENERGY EFFICIENCY

9.1 Product Information Sheet and Product Information according to (EU) No 65/2014 and (EU) No 66/2014

Supplier's name	Electrolux
Model identification	EOFF4P0PX2 949288083 EOFF7P00H 949288085 EOFF7P86H2 949288092 EOM7P00Z 949288087 EOM7P10H 949288095 KOFCP00H 949288068 KOFCP30H 949288086 KOFCP86H 949288091 KOFFP0PX 949288084 OOPP00NB 949288061 XOP3PNK 949288057
Energy Efficiency Index	61.2
Energy efficiency class	A++
Energy consumption with a standard load, conventional mode	0.93 kWh/cycle
Energy consumption with a standard load, fan-forced mode	0.52 kWh/cycle
Number of cavities	1
Heat source	Electricity

Volume	72 l	
Type of oven	Built-In Oven	
Mass	EOFF4P0PX2	29.2 kg
	EOFF7P00H	29.6 kg
	EOFF7P86H2	29.6 kg
	EOM7P00Z	29.6 kg
	EOM7P10H	29.6 kg
	KOFCP00H	30.4 kg
	KOFCP30H	29.6 kg
	KOFCP86H	29.6 kg
	KOFFP0PX	29.6 kg
	OOPP00NB	29.6 kg
	XOP3PNK	32.0 kg

Appliance tested according to: EN IEC 60350-1.

9.2 Information requirements according to (EU) No 2023/826

Power consumption in standby	0.8 W
Maximum time needed for the equipment to automatically reach the applicable low power mode	20 min

Appliance tested according to: EN 50564.

9.3 Energy saving tips

- Keep the door closed during cooking and avoid opening it often.
- Keep the door gasket clean and make sure it is well fixed in its position.
- Use metal or dark, non-reflective cookware.
- Skip preheating unless needed.
- Minimize breaks between baking multiple dishes.
- When possible, use the cooking functions with fan to save energy (selected models only).
- Use residual heat to keep food warm. Reduce the appliance temperature to minimum 3 - 10 min before the end of cooking.

- Turn off the lamp during cooking unless needed. Refer to Settings.
- Moist Fan Baking (selected models only) - this function was used to comply with the energy efficiency class and ecodesign requirements (according to EU 65/2014 and EU 66/2014). Tests according to: IEC/EN 60350-1. The oven door should be closed during cooking so that the function is not interrupted and the oven operates with the highest energy efficiency possible. When you use this function the lamp automatically turns off. In some models it takes 30 sec.
- Automatic switch-off - for safety reasons, if the heating function is active and no settings are changed, the appliance will turn off automatically after a certain period of time. If you intend to run a heating function for a duration exceeding the automatic switch-off time, set the cooking time.
 - 12.5 h: 30-115 °C
 - 8.5 h: 120-195 °C
 - 5.5 h: 200-245 °C
 - 3 h: 250-maximum °C

10. ENVIRONMENTAL CONCERNS

Recycle materials with the symbol . Put the packaging in relevant containers to recycle it. Help protect the environment and human health by recycling waste of electrical and electronic appliances. Do not dispose of ap-

pliances marked with the symbol  with the household waste. Return the product to your local recycling facility or contact your municipal office.

